

**STOCKED REPLACEMENT BIBB SEATS...**

**SEATS SHOWN ACTUAL SIZE**

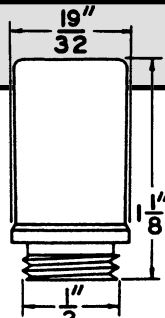

**UNION BRASS**  
 18T • PLATED BRASS

30063- No. 64  $3\frac{3}{64}$  x 18 x  $1\frac{13}{16}$

SEAT -  
 $1\frac{1}{2}$  X 24 X  $1\frac{15}{32}$

S1091G-

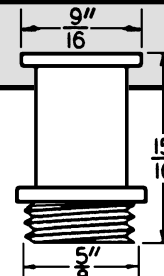

**UNION BRASS**  
 18T • PLATED BRASS • 2638

30136- No. 137  $\frac{5}{8}$  x 18 x  $1\frac{15}{16}$

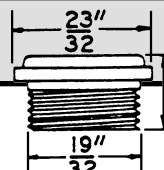

**WOLVERINE**  
 24T • PLATED BRASS

30031- No. 32  $1\frac{1}{2}$  x 24 x  $1\frac{15}{32}$

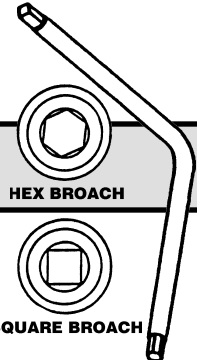

**BIBB SEAT WRENCH**  
 UNIVERSAL STYLE • HEX BROACH ON ONE END & SQUARE ON THE OTHER • CASE HARDENED • CADMIUM PLATED

60532-

HEX BROACH

SQUARE BROACH

**STOCKED REPLACEMENT "O" RINGS...**

**SHOWN ACTUAL SIZE**



**O-RING -  $\frac{7}{16}$ " x  $\frac{5}{16}$ " x  $\frac{1}{16}$ "**  
 CENTRAL, WALLACEBURG, KOHLER, CUTHBERT, MUELLER,  
 SLOAN, CRANE, SPEAKMAN, STERLING, WALTEC, INDIANA

35723- No. 6



**O-RING -  $\frac{11}{16}$ " x  $\frac{1}{2}$ " x  $\frac{3}{32}$ "**  
 MOEN, DUOMASTER #10, INDIANA, ELJER, WOLVERINE, GERBER,  
 SPEAKMAN, WATROUS, ALAMARK

35727- No. 10



**O-RING -  $\frac{1}{2}$ " x  $\frac{3}{8}$ " x  $\frac{1}{16}$ "**  
 AMERICAN STANDARD, KOHLER, MUELLER, POWERS, WALTEC,  
 WALTROUS, UNIVERSAL-RUNDLE, SAYCO, MICHIGAN

35724- No. 7



**O-RING -  $\frac{3}{4}$ " x  $\frac{9}{16}$ " x  $\frac{3}{32}$ "**  
 PRICE PFISTER, STANADYNE, SPEAKMAN, STERLING, TECK,  
 KOHLER, CRANE, CUTHBERT, JAMECO, MUELLER

35728- No. 11



**O-RING -  $\frac{9}{16}$ " x  $\frac{3}{8}$ " x  $\frac{3}{32}$ "**  
 CUTHBERT, CYGNET, JAMECO, VALLEY, PRICE PFISTER,  
 GERBER, HARCRAFT, SAVOY, WALTEC, AQUALINE

35725- No. 8



**O-RING -  $\frac{13}{16}$ " x  $\frac{5}{8}$ " x  $\frac{3}{32}$ "**  
 PRICE PFISTER, ARROWHEAD, MOEN, STANDARD, SPEAKMAN,  
 UNIVERSAL-RUNDLE, CUTHBERT

35729- No. 12



**O-RING -  $\frac{5}{8}$ " x  $\frac{7}{16}$ " x  $\frac{3}{32}$ "**  
 CENTRAL, SALTER, SCOVILL, SAVOY, GERBER, INDIANA  
 CRANE, "HI-LO" BALLCOCK, SPEAKMAN, GYRO, BARNES

35726- No. 9



**O-RING -  $\frac{7}{8}$ " x  $\frac{11}{16}$ " x  $\frac{3}{32}$ "**  
 AMERICAN STANDARD, CUTHBERT, JAMECO, KOHLER,  
 MUELLER, MULLINS, BRIGGS, REPLUBLIC, DISHMASTER

35730- No. 13

continued on next page

STOCKED REPLACEMENT "O" RINGS...

SHOWN ACTUAL SIZE



O-RING - 15/16" x 3/4" x 3/32"  
UNION BRASS, YOUNGSTOWN, INDIANA, KOHLER, GERGER, STANDARD, MCDONALD, SPEAKMAN, HARVEY, SAYCO,  
GOPHER, CUTHBERT, VALLEY

35731- No. 14

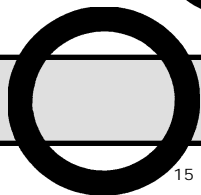

O-RING - 1" x 3/4" x 1/8"  
CRANE

35732- No. 15

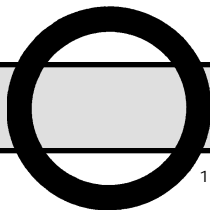

O-RING - 1 1/16" x 13/15" x 1/8"  
MOEN, AMERICAN KITCHENS, CROSLLEY, YOUNGSTOWN, ELJER, GYRO, HOTPOINT

35733- No. 16

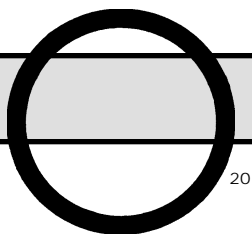

O-RING - 1 3/16" x 1" x 3/32"  
AMERICAN STANDARD, STATIC-SEAL FOR AQUA-SEAL, ALAMARK, ELJER, JAMECO, SPEAKMAN, TECK

35737- No. 20

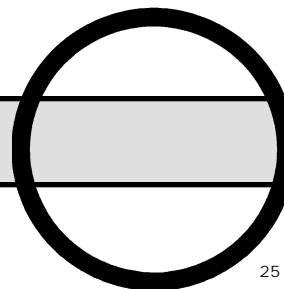

O-RING - 1 1/2" x 1 5/16" x 3/32"  
DELTA SINGLE LEVER, VALLEY

35739- No. 25

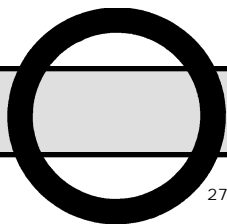

O-RING - 1 1/8" x 7/8" x 1/8"  
MOEN 42E, ALAMARK, HARCRAFT, STERLING FAUCET, TRACY, REPCAL, DELTA (DELEX)

35741- No. 27



O-RING - 5/8" x 1/2" x 1/16"  
DELTA DIVERTER ASSEMBLY, CUTHBERT, KOHLER

35742- No. 28

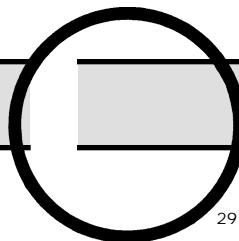

O-RING - 1 1/4" x 1 1/8" x 1/16"  
DELTA CAM ASSEMBLY, SYMMONS

35743- No. 29

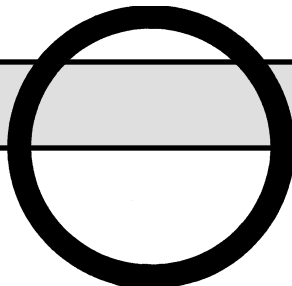

O-RING - 1 1/2" x 1 1/4" x 1/8"  
MOEN 42E, DELTA, SLOAN, SYMMONS

35748- No. 34

STOCKED REPLACEMENT "O" RINGS...

SHOWN ACTUAL SIZE



O-RING - 5/16" x 3/16" x 1/16"  
AMERICAN STANDARD B/C PLUNGER, KOHLER B/C, WALTEC, SPEAKMAN SELF CLOSING FAUCETS,

35750- No. 36

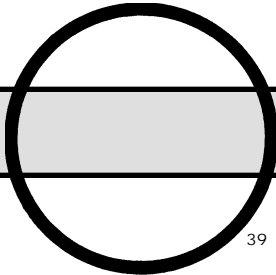

O-RING - 1 7/16" x 1 5/16" x 1/16"  
NILE, MOEN SPOUT

35753- No. 39

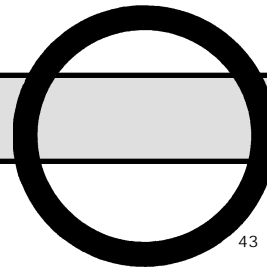

O-RING - 1 3/8" x 1 1/8" x 1/8"  
MOEN, ALAMARK

35757- No. 43

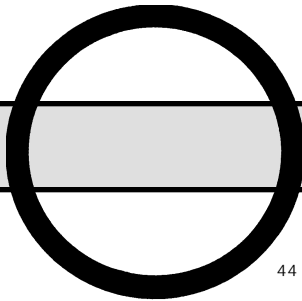

O-RING - 1 9/16" x 1 5/16" x 1/8"  
MOEN SPOUT, CUTHBERT

35758- No. 44



O-RING - 11/32" x 7/32" x 1/16"  
KOHLER FLUSH VALVE, WALTEC

35761- No. 47



O-RING - 1/4" x 1/8" x 1/16"  
MINNEAPOLIS-HONEYWELL CONTROL

35774- No. 60

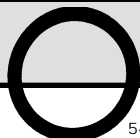

O-RING - 1 1/16" x 9/16" x 1/16"  
AMERICAN STANDARD PUSH-PULL BATH

35768- No. 54



O-RING - 9/32" x 5/32" x 1/16"  
THRUSH VALVES

35775- No. 61

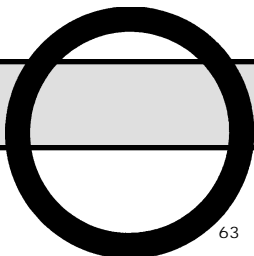

O-RING - 1 5/16" x 1 1/16" x 1/8"  
WOLVERINE

35777- No. 63

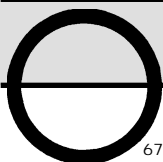

O-RING - 1 3/16" x 1 1/16" x 1/16"  
CUTHBERT, DELTA (DELEX), VALLEY, WALLACEBURG, WALTEC

35784- No. 67

continued on next page

**STOCKED REPLACEMENT "O" RINGS...**

**SHOWN ACTUAL SIZE**

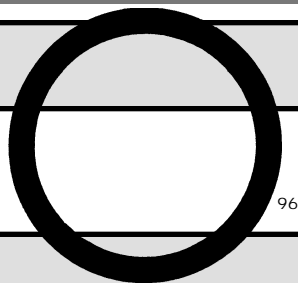

O-RING - 1<sup>7</sup>/<sub>16</sub>" x 1<sup>3</sup>/<sub>16</sub>" x 1<sup>1</sup>/<sub>8</sub>"  
VARIOUS

35876- No. 96

O-RING - 1<sup>11</sup>/<sub>16</sub>" x 1<sup>7</sup>/<sub>16</sub>" x 1<sup>1</sup>/<sub>8</sub>"  
VARIOUS

35878- No. 98

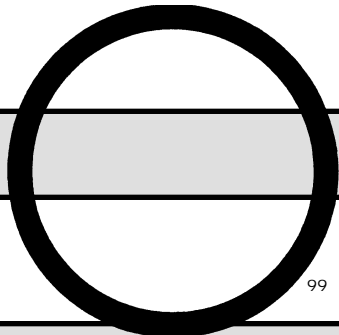
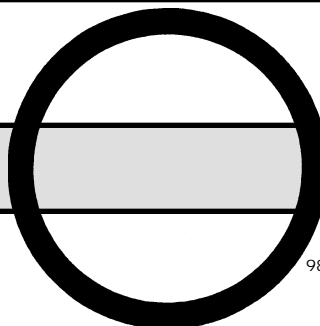

O-RING - 1<sup>3</sup>/<sub>4</sub>" x 1<sup>1</sup>/<sub>2</sub>" x 1<sup>1</sup>/<sub>8</sub>"  
VARIOUS

35879- No. 99

O-RING - ASSORTMENT  
CONTAINS 180 PIECES OF 12 DIFFERENT SIZES • PLASTIC BOX

39968-

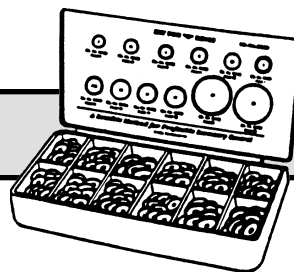

**STOCKED WASHER RETAINERS...**



RETAINER - 00 CUP

35108-



RETAINER - 3/8 CUP

35112-



RETAINER - 0 CUP

35109-



RETAINER - 1/2 L CUP

35116-



RETAINER - 1/4 CUP

35110-



RETAINER - 1/4 L CUP

35111-

For More Information On These Products Or  
On Products Not Listed, Call  
**Salina Supply Company** At (785) 823-2221