

ROUGH BRASS

* Price Change
** Desc. Change

BRASS BOILER DRAIN

MIP X HOSE THREAD OUTLET • RISING STEM • SIX-POINT CAST-IRON HANDLE



SSC No.	Manuf No.	Size	Wgt	Price Each
20K 7400	102-003	1/2" x 3/4"	.44 lbs	\$ 4.50**
20K 7500	102-004	3/4" x 3/4"	.46 lbs	5.08**

QUARTER-TURN BOILER DRAIN

HEAVY BRASS CONSTRUCTION • CUP OR MALE IRON PIPE THREADS TO HOSE



SSC No.	Manuf No.	Size	Wgt	Price Each
20K 0020	102-053HN	1/2"	.40 lbs	\$ 5.81*
20K 0030	102-054HN	3/4"	.42 lbs	9.63

QUARTER-TURN FNPT BOILER DRAIN

FNPT INLET X MIGHT OUTLET • LEAD FREE FORGED BRASS



SSC No.	Manuf No.	Size	Wgt	Price Each
20K 0040	R-672NL	1/2"	.42 lbs	\$ 11.64*
20K 0050	R-672NL	3/4"	.46 lbs	12.17*

QUARTER-TURN ANGLE SILLCOCK

HEAVY BRASS CONSTRUCTION • THREADED TO HOSE

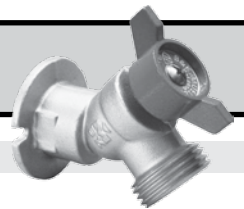

SSC No.	Manuf No.	Size	Wgt	Price Each
20K 0140	108-053HN	1/2"	.44 lbs	\$ 10.84
20K 0150	108-054HN	3/4"	.48 lbs	11.41

QUARTER-TURN HOSE BIBB VALVE

HEAVY BRASS CONSTRUCTION • CUP OR MALE IRON PIPE THREADS TO HOSE



SSC No.	Manuf No.	Size	Wgt	Price Each
20K 0160	103-053HN	1/2"	.40 lbs	\$ 8.33
20K 0170	103-054HN	3/4"	.42 lbs	6.92

For More Information On These Products Or On Products Not Listed,
Call *Salina Supply Company* At (785) 823-2221

WASHING MACHINE BOXES * Price Change

CENTER DRAIN OUTLET BOX WITH DRYER RECEPTACLES

•16 GAUGE METAL WITH EPOXY FINISH •DUPLIX ELECTRIC GROUNDING •RECEPTACLE & DRYER OUTLET
•1/2" COMBINATION MPT BRASS SWEAT CONNECTIONS

SSC No.	Manuf No.	Drain	Overall Size	Rough Wall Opening	Wgt.	Price Each
20K 0360	82034/BED200	2"	9" x 14 ³ / ₄ "	6 ¹ / ₄ " x 13 ¹ / ₂ " x 4"	9.0 Lbs	\$ 172.97 *

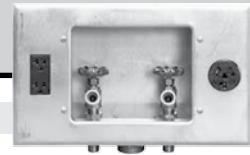

CENTER DRAIN OUTLET BOX WITH VALVES

•20 GAUGE METAL •WHITE POWDER COATED •FITTINGS INCLUDED •1/2" PVC DRAIN
•KNOCKOUTS AT BOTTOM, TOP & SIDES •1/2" MIP SWEAT CONNECTION VALVES

SSC No.	Manuf No.	Drain	Overall Size	Rough Wall Opening	Wgt.	Price Each
20K 0370	82129/T150TPPVC	1 ¹ / ₂ "	9 ¹ / ₄ " x 14"	8 ¹ / ₄ " x 12 ³ / ₄ " x 4"	6.5 Lbs	\$ 98.17 *



REVERSIBLE METAL OUTLET BOX WITH VALVES

•FOR WASHING MACHINE •CONVERTS FROM RIGHT HAND DRAIN TO LEFT HAND DRAIN



SSC No.	Manuf No.	Drain	Overall Size	Rough Wall Opening	Wgt.	Price Each
20K 0380	38981/T200TP	2"	MIP Valve With Long Shank Adpater		6.5 Lbs	\$ 84.83



CENTER DRAIN OUTLET BOX WITH RECEPTACLES ON RIGHT

•1/2" MIP/SWEAT VALVES •2" THREADED DRAIN •20 AMP, 125 VOLT DUPLEX & 30 AMP, 250 VOLT 4 WIRE RECEPTACLES
•20 GA. G90 HOT DIPPED UNPAINTED GALV. STEEL BOX & FACEPLATE • MALE THREADED DRAIN FITTING & LOCKNUT

SSC No.	Manuf No.	Drain	Overall Size	Rough Wall Opening	Wgt.	Price Each
20K 0385	82035/NWBED2004	2"	15 ³ / ₄ " x 9 ¹ / ₂ "	14" x 8 ³ / ₄ " x 3 ¹ / ₂ "	8.7 Lbs	\$ 181.01



CENTRO II™ PLASTIC SUPPLY DRAIN OUTLET BOX

•FOR WASHING MACHINE •2" KNOCKOUT DRAIN CAPS •2 SUPPORT BRACKETS



SSC No.	Manuf No.	Drain	Overall Size	Rough Wall Opening	Wgt.	Price Each
20K 0390	38121		Plain PVC Plastic Box - Valves Not Included		1.10 lbs	\$ 8.24 *



VALVES NOT INCLUDED

QUADTRO™ 1/4 TURN VALVE WASHER BOX

•COPPER SWEAT BRASS BALL VALVES • TOP OR BOTTOM VALVE MOUNT • POLYSTYRENE



SSC No.	Manuf No.	Drain	Overall Size	Rough Wall Opening	Wgt.	Price Each
20K 4200	38530/38676	2"	8 ³ / ₄ " W x 7 ¹ / ₂ " H x 3 ⁵ / ₈ " D		1.70 lbs	\$ 33.94 *

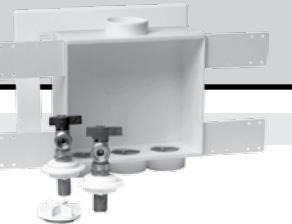

QUADTRO™ 1/4 TURN PEX VALVE WASHER BOX

•1/2" ASTM F1807 PEX BRASS BALL VALVES • TOP OR BOTTOM VALVE MOUNT • POLYSTYRENE



SSC No.	Manuf No.	Drain	Overall Size	Rough Wall Opening	Wgt.	Price Each
20K 4225	38532	2"	8 ³ / ₄ " W x 7 ¹ / ₂ " H x 3 ⁵ / ₈ " D		1.70 lbs	\$ 33.95 *

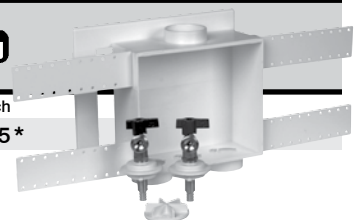

continued on next page

WASHING MACHINE BOXES

*Price Change

WASHING MACHINE BOX WITH DOUBLE OUTLET

• ONE LONG SHANK SINGLE LEVER VALVE • BOX 8" X 6¹/₂" X 3³/₈" • FACEPLATE 10¹/₄" X 8¹/₂"



SSC No.	Manuf No.	Size	Wgt.	Price Each
20K 4250	38660	1 ¹ / ₂ " To 2" For Right Or Left Hand Drain	2.11 lbs	\$ 68.49

NO-BURST WASHING MACHINE CONNECTORS

• FLEXIBLE BRAIDED STAINLESS STEEL • HIGH PRESSURE TEMPERATURE TEST TO 230°F • CODE APPROVED
• 3/4" HOSE FITTING X 3/4" HOSE FITTING X 48" LONG • EASY TO HOOK-UP

SSC No.	Manuf No.	Size	Wgt.	Price Each
20J 9100	B9WM48	3/4" x 3/4" x 48"	1 lb	\$ 10.18 *



ICE MAKER OUTLET BOX

• QUICK, SAFE WATER SUPPLY & SHUTOFF • HIGH IMPACT POLYSTYRENE • 2 SUPPORT BRACKETS
• BOX IS 6" W X 6" H X 3³/₈" D • FACEPLATE IS 8¹/₄" W X 8¹/₄" H • 1/4 TURN VALVE



SSC No.	Manuf No.	Size	Wgt.	Price Each
20K 4500	38681/39156	With 1/4 Turn Valve Installed	1.2 lbs	\$ 25.73

1/2K™ MINI ICE MAKER BOXES WITH NAILS

• NAILS PRELOADED (NO SUPPORT BRACKET NEEDED) • RIGHT OR LEFT HAND INSTALLATION
• BOX IS 3.20" W X 4.15" H X 2.35" D • FACEPLATE IS 3.20" W X 5.89" H X .50" D • 1/4 BRASS VALVE



SSC No.	Manuf No.	Size	Wgt.	Price Each
20K 4600	38611	With 1/4 MIP Brass Ball Valve Installed	0.8 lbs	\$ 27.50
20K 4650	39136	With 1/4 Pex Brass Ball Valve Installed	0.8 lbs	28.20 *

84" STAINLESS STEEL BRAIDED ICE MAKER CONNECTOR

SSC No.	Manuf No.	Size	Price Each
20J 9200	12IM84	1/4" Compression x 1/4" Compression x 84"	\$ 16.50

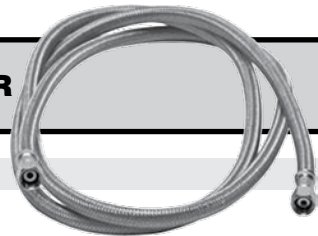

ACCESS PANEL

• MADE OF ABS WITH U.V. STABILIZERS • PANEL SNAPS INTO FRAME • FITS FLUSH WITH WALL
• EASY TO INSTALL • CAN BE INSTALLED IN ANY WALL THICKNESS OR IN CEILING • PAINTABLE



SSC No.	Manuf No.	Size	Price Each
20K 5000	34056	14" x 14" ABS	\$ 19.46 *

SPRINGFIT ACCESS PANEL

• WALL MOUNTABLE PANEL CAN BE PAINTED OR WALLPAPERED
• FOR RESIDENTIAL & COMMERCIAL APPLICATIONS





SSC No.	Manuf No.	Size	Price Each
20K 5100	APU-9	9" x 9"	\$ 22.74 *

continued on next page

HOSE NIPPLES Jones Stephens Corp. *Price Change

HOSE NIPPLES 1 PIECE BRASS				JSC 
SSC No.	Manuf No.	Size	Price Each	
58F 3610	G20-002	1/2" MIP x 3/4" MHT	\$ 5.28 *	
58F 3760	G20-010	1/2" FIP x 3/4" MHT	3.39	
58F 3810	G20-016	3/4" MIP x 3/4" FHT	5.35	
58F 3910	G20-011	3/4" FIP x 3/4" MHT	5.31	
58F 4060	G20-021	3/4" FIP x 3/4" FHT	6.17 *	
58F 4210	G20-005	1/2" MIP x 3/4" FHT	4.29	
58F 4260	G20-003	3/4 MIP/1/2" FIP x 3/4" MHT	5.14	

SWIVEL TYPE HOSE NIPPLE				JSC 
SSC No.	Manuf No.	Size	Price Each	
58F 3860	G20-031	1/2" FIP x 3/4" FHT	\$ 5.63	
58F 4070	G20-032	3/4" FIP x 3/4" FHT	6.51	

HOSE CAP				JSC 
SSC No.	Manuf No.	Size	Price Each	
58F 4275	G20-055	3/4"	\$ 2.81 *	

HOSE ADAPTER			
58F 4110	GHC-1	3/4" FHT x 1/8" FIP	\$ 2.44

WALL HYDRANTS * Price Change ** New Product

WALL HYDRANTS				
FEMALE IRON PIPE • FROST PROOF • REGULAR OR ANTI SIPHON				
SSC No.	Manuf No.	Size	Price Each	
24B 6000	455	1/2" x 10"	FEMALE IRON PIPE	\$ 36.82
24B 6020	455	1/2" x 12"	FEMALE IRON PIPE	37.81
24B 6040	455	1/2" x 14"	FEMALE IRON PIPE	39.18

ANTI-SIPHON WALL HYDRANT				
24B 6200	465-10BCLD	1/2" x 10"	1/2" MALE PIPE THREAD & 1/2" FEMALE COPPER	\$ 57.24
24B 6220	465-12BCLD	1/2" x 12"	1/2" MALE PIPE THREAD & 1/2" FEMALE COPPER	58.40
24B 6240	465-14BCLD	1/2" x 14"	1/2" MALE PIPE THREAD & 1/2" FEMALE COPPER	60.14
24B 6300	469-12QTLF	1/2" x 12"	1/2" PEX CRIMP & 1/2" PEX CRIMP	\$ 53.14

FREEZELESS COMMERCIAL WALL HYDRANT

•AUTOMATIC DRAINING •VACUUM BREAKER/BACKFLOW PREVENTER

SSC No.	Manuf No.	Size	Price Each	
24B 1900	HY420-12-88/65P	3/4" x 12"	1/2" FEMALE & 3/4" MALE PIPE THREAD INLET	\$ 246.33

QUARTER TURN FREEZELESS WALL HYDRANT

ANTI-SIPHON VACUUM BREAKER WITH BACKFLOW CHECK VALVE
SOLID BRASS BODY, VALVE STEM CAP, SEAT & STEM ENDS

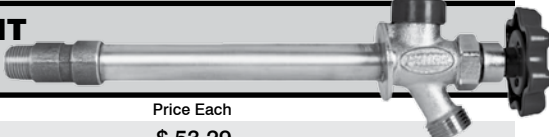
SSC No.	Manuf No.	Size	Price Each	
24B 8000	P-164D	1/2" x 10"	1/2" MALE PIPE THREAD & 1/2" SWEAT	\$ 53.29
24B 8050	P-164D	1/2" x 12"	1/2" MALE PIPE THREAD & 1/2" SWEAT	56.51
24B 8100	P-164D	1/2" x 14"	1/2" MALE PIPE THREAD & 1/2" SWEAT	59.60
24B 8125	P-164T	3/4" x 10"	3/4" MALE PIPE THREAD & 1/2" FEMALE PIPE THREAD	\$ 57.04 **
24B 8150	P-164T	3/4" x 12"	3/4" MALE PIPE THREAD & 1/2" FEMALE PIPE THREAD	64.74 *
24B 8200	P-164T	3/4" x 14"	3/4" MALE PIPE THREAD & 1/2" FEMALE PIPE THREAD	67.67 *



continued on next page

ROUGH BRASS HYDRANTS

WOODFORD WALL HYDRANTS

**MODEL 14
FREEZELESS OUTSIDE WALL HYDRANT**



SSC No.	Manuf No.	Size		Price Each
24B 1200	14C	1/2" x 8"	COPPER WATER TUBE INLET - 1/2" K,L,M INSIDE & 3/4" M OUTSIDE	\$ 34.31
24B 1300	14C	1/2" x 10"	COPPER WATER TUBE INLET - 1/2" K,L,M INSIDE & 3/4" M OUTSIDE	36.26
24B 1310	14C	1/2" x 12"	COPPER WATER TUBE INLET - 1/2" K,L,M INSIDE & 3/4" M OUTSIDE	38.22
24B 1320	14C	1/2" x 14"	COPPER WATER TUBE INLET - 1/2" K,L,M INSIDE & 3/4" M OUTSIDE	40.17
24B 1500	14P	1/2" x 8"	1/2" FEMALE & 3/4" MALE PIPE THREAD INLET	\$ 35.78
24B 1510	14P	1/2" x 10"	1/2" FEMALE & 3/4" MALE PIPE THREAD INLET	37.73
24B 1610	14P	1/2" x 12"	1/2" FEMALE & 3/4" MALE PIPE THREAD INLET	39.68
24B 1810	14P	1/2" x 14"	1/2" FEMALE & 3/4" MALE PIPE THREAD INLET	41.63
24B 1820	14P	1/2" x 18"	1/2" FEMALE & 3/4" MALE PIPE THREAD INLET	45.53
24B 1822	14CP	1/2" x 8"	1/2" MALE PIPE THREAD & 1/2" FEMALE COPPER WATER TUBE INLET	\$ 34.31
24B 1824	14CP	1/2" x 10"	1/2" MALE PIPE THREAD & 1/2" FEMALE COPPER WATER TUBE INLET	36.26
24B 1826	14CP	1/2" x 12"	1/2" MALE PIPE THREAD & 1/2" FEMALE COPPER WATER TUBE INLET	38.22
24B 1828	14CP	1/2" x 14"	1/2" MALE PIPE THREAD & 1/2" FEMALE COPPER WATER TUBE INLET	40.17

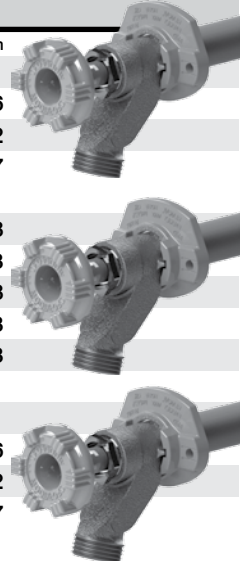

**MODEL 17
ANTI-SIPHON FREEZELESS OUTSIDE WALL HYDRANT**



SSC No.	Manuf No.	Size		Price Each
24B 0010	17P	1/2" x 8"	1/2" FEMALE & 3/4" MALE PIPE THREAD INLET	\$ 40.79
24B 0100	17P	1/2" x 10"	1/2" FEMALE & 3/4" MALE PIPE THREAD INLET	42.74
24B 0110	17P	1/2" x 12"	1/2" FEMALE & 3/4" MALE PIPE THREAD INLET	44.69
24B 0120	17P	1/2" x 14"	1/2" FEMALE & 3/4" MALE PIPE THREAD INLET	46.64
24B 0200	17CP	1/2" x 10"	1/2" MALE PIPE THREAD & 1/2" FEMALE COPPER WATER TUBE INLET	\$ 41.27
24B 0210	17CP	1/2" x 12"	1/2" MALE PIPE THREAD & 1/2" FEMALE COPPER WATER TUBE INLET	43.22
24B 0220	17CP	1/2" x 14"	1/2" MALE PIPE THREAD & 1/2" FEMALE COPPER WATER TUBE INLET	45.17

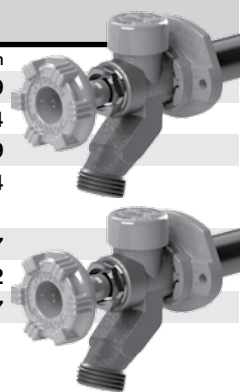

For More Information On These Products Or On Products Not Listed,
Call *Salina Supply Company* At (785) 823-2221

**MODEL 25
AUTOMATIC DRAINING OUTSIDE WALL HYDRANT**
FREEZELESS • WITH VACUUM BREAKER & BACKFLOW PREVENTER

SSC No.	Manuf No.	Size		Price Each
24B 1831	25CP	1/2" x 10"	1/2" MALE PIPE THREAD & 1/2" FEMALE COPPER WATER TUBE INLET	\$ 70.13
24B 1832	25CP	1/2" x 12"	1/2" MALE PIPE THREAD & 1/2" FEMALE COPPER WATER TUBE INLET	72.13
24B 1835	25CP	1/2" x 18"	1/2" MALE PIPE THREAD & 1/2" FEMALE COPPER WATER TUBE INLET	78.11

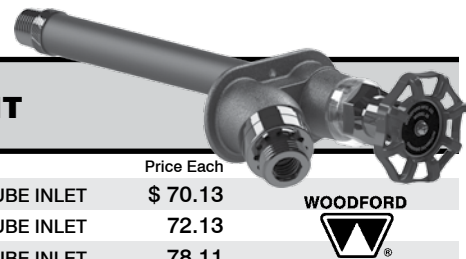

ROUGH BRASS HYDRANTS

WOODFORD FREEZELESS YARD HYDRANTS

* Price Change
** New Product

IOWA Y-34 FREEZELESS YARD HYDRANTS TOGGLE LEVER CONTROL • VARIABLE FLOW • FLOWFINDER & LOCK

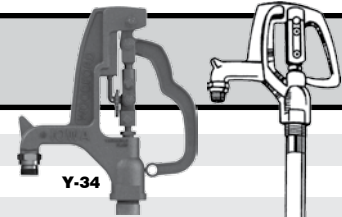

SSC No.	Manuf No.	Inlet	Outlet	Lgth	Wgt	Price Each
24B 2610	Y-34	3/4" F.P.T.	3/4" M.H.	2'	17 Lbs	\$ 132.45
24B 2710	Y-34	3/4" F.P.T.	3/4" M.H.	3'	19 Lbs	141.49 *
24B 2810	Y-34	3/4" F.P.T.	3/4" M.H.	4'	22 Lbs	149.14 *

Y-34
Y-1

IOWA Y-1 FREEZELESS YARD HYDRANT TOGGLE LEVER CONTROL • VARIABLE FLOW • TAMPERPROOF LOCK

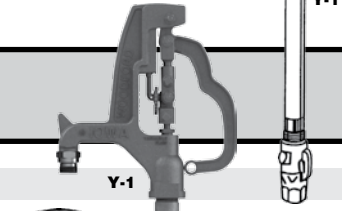

SSC No.	Manuf No.	Inlet	Outlet	Lgth	Wgt	Price Each
24B 2910	Y-1	1" F.P.T.	3/4" M.H.	3'	21 Lbs	\$ 188.27 *

Y-1

IOWA W-34 FREEZELESS YARD HYDRANT TOGGLE LEVER CONTROL • VARIABLE FLOW • TAMPERPROOF LOCK

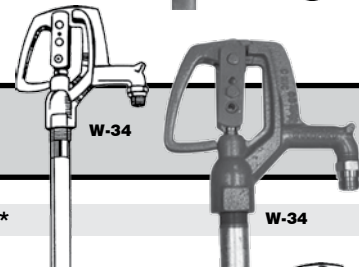

SSC No.	Manuf No.	Inlet	Outlet	Lgth	Wgt	Price Each
24B 2720	W-34	3/4" F.P.T.	3/4" M.H.	3'	18 Lbs	\$ 124.75 *

W-34

W-34

IOWA X-34 FREEZELESS YARD HYDRANT TOGGLE LEVER CONTROL • VARIABLE FLOW • TAMPERPROOF LOCK

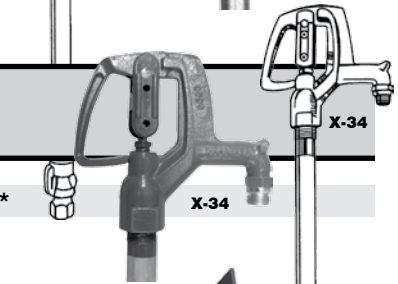

SSC No.	Manuf No.	Inlet	Outlet	Lgth	Wgt	Price Each
24B 2725	X-34	3/4" F.P.T.	3/4" M.H.	3'	18 Lbs	\$ 105.33 *

X-34

X-34

IOWA Y-95 FREEZELESS ANIT-SIPHON YARD HYDRANT AUTOMATIC DRAIN • BRASS WORKING PARTS & CASTING • TAMPERPROOF

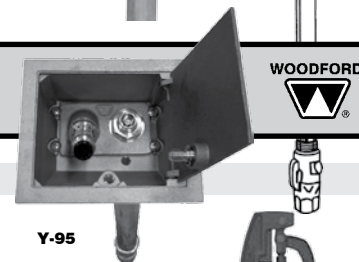

SSC No.	Manuf No.	Size	Lgth	Wgt	Price Each
24B 2730	Y-95	3/4" Threads	3'	18 Lbs	\$ 531.49

Y-95



MODEL S3 FREEZELESS AUTO DRAIN SANITARY YARD HYDRANT BACKFLOW PROTECTED • AUTOMATIC DRAINING • 20 PSI MIN • 100 PSI MAX • 120°F MAX

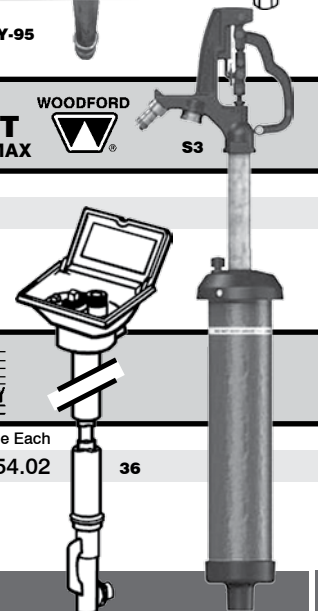

S3

SSC No.	Manuf No.	Inlet	Outlet	Lgth	Wgt	Price Each
24B 6503	S3	1" N.P.T.	3/4" M.H.	3'	36 Lbs	\$ 921.76 **

TOTAL ECLIPSE 36 FREEZELESS STREET WASHER AUTO DRAIN • BRASS WORKING PARTS • CAST IRON

THE KUPFERLE FOUNDRY COMPANY

SSC No.	Manuf No.	Size	Lgth	Price Each
24B 4410	36	3/4" Threads	3'	\$ 354.02

36

ROUGH BRASS HYDRANTS